

ROOFER'S GUIDE

I**KO**[®] **COMMERCIAL**[®]

Specify with Confidence.



IKO.COM/COMM



COMMERCIAL

Specify with Confidence.

IKO is pleased to offer this convenient guide covering some installation basics of our commercial roofing products and systems. This quick reference booklet is meant to be a general guide only.

For more complete installation requirements, refer to the IKO Technical Specifications Manual.



TABLE OF CONTENTS

ROOF SAFETY	4-5
PRODUCT STORAGE AND HANDLING	6-7
PRO APPLICATION TIPS	8-11
INSTALLATION — Insulation and Cover Board	12-17
General Requirements	12-13
Adhesive-Adhered	14-15
Mechanical Attachment	16
Hot Asphalt-Adhered	17
INSTALLATION — SBS Membranes	18-31
General Requirements	18-19
Heat-Welded	20-21
Flame-Free — “Picture Framing”	22
Hot Asphalt-Adhered	23-24
Multiple-Ply “Hybrid” Membrane Roofing System	25
Cold Adhesive-Adhered	26
Self-Adhered	27-28
Mechanically Fastened	29-31
MODIFIED BITUMEN FLASHING DETAILS	32-64
MORE DETAIL DRAWINGS	65
Built-Up Roofing (BUR) Flashing Details	65
Insulation and Cover Board Fastening Details	65

ROOF SAFETY



Working on a roof is potentially dangerous, and workers must be properly trained and equipped to prevent injury to themselves, building occupants or other trades. Local labour departments typically dictate job site and employee safety precautions, equipment and training required; however, the following partial reminder list may be helpful to raise awareness of the many hazards associated with roofing work:

- Working at heights (e.g., fall-arrest prevention, guardrails).
- Hot materials (e.g., asphalt kettles, open flames).
- Propane.
- Electrical risks (e.g., overhead wires, live conduits under the roof deck).
- Risks and hazards from other trades.
- Power tools (e.g., saws, drills, nail guns, etc.).
- Ladders and scaffolds.
- Material safety (e.g., materials such as solvent-based adhesives).
- Roof openings/skylights and roof height changes.
- Housekeeping issues.
- First aid/CPR training.
- Falling objects (hazard to workers at ground level).
- Wearing PPE.

Roof Safety Literature

Various Canadian provincial safety associations have also published comprehensive roof safety literature. For example, WorkSafeBC offers a good overview of roof safety procedures in its downloadable PDF booklet available here:



Use of open flames in heat-welding membranes is a unique safety concern in roof installation. In these situations, the following safety reminders may be useful, but do not supplant a comprehensive roof fire safety program:

1. Do not torch directly to combustible substrates, such as flashings, corners or voids in the roof deck.
2. Do not torch directly at any corner or joint; instead, torch the membrane to be applied and then install it in the corner/joint.
3. Use caution when torching near pipes in the event there is suction present.
4. Maintain a person on-site for a period of not less than 60 minutes after the last torch has been put out to monitor the roof for flames, smoke or smoldering insulation. Material can smolder for hours before igniting. An infrared heat gun should be used to monitor readings. A fire extinguisher is required on-site. Have a 120-lb. dry chemical fire extinguisher within 6 m (20 ft) of each worker using a torch.

PRODUCT STORAGE AND HANDLING

IKO recommends the storage procedures outlined in the following chart to minimize product damage and help ensure optimum product performance during storage and subsequent installation on the roof.

Job Site Storage on Rooftop

Product	Cover With Tarp	Store Upright	Store Salvage Up	Keep in Shade During Hot Temperatures (Above 27°C)	Keep Warm During Cold Temperatures (Below 5°C)
Felts (Organic/Inorganic)	X	X			
Torchflex™/Modiflex™	X*	X	X		
Self-Adhered	X*	X	X	X**	X
Kraft Vapour Retarder	X				
Polyisocyanurate	X			Slit packaging ends and cover with tarp.	
Protectoboard™	X			Slit packaging ends and cover with tarp.	
Protectobase™	X				
ShieldBase™	X				
Asphalt (Keg Format)	X	X		X	
Easy-Melt™ 200				X	
IKO S.A.M.® Adhesive		X		X**	X
IKO Mod-Bit Primer		X		X**	X
IKO Asphalt Primer		X		X**	X
IKO ArmourReflect®		X		X**	X
IKO Cold Gold® Adhesive				X**	X

Note: Do not double-stack pallets.

*Product only needs to be tarped after the factory packaging is removed.

**Store between 5°C and 27°C.

- All products to be stored on raised pallets at least 4 inches above roof surface.
- Refer to product's Material Safety Data Sheet.
- Immediately repair any tears in packaging and/or properly cover material with waterproof tarp.
- When stocking the roof, always consider the effect of loads on the structure and decking. Avoid stockpiling materials on the roof without first obtaining permission from the building owner.
- Store all roofing materials in a dry, well-ventilated area.
- During winter, it is recommended to store roll goods in areas with above-freezing temperatures.
- Store pails of adhesive and mastic between 5°C and 27°C (40°F-80°F).
- All materials damaged during storage or transport, and deemed problematic, shall be removed from the job site and replaced.
- During heavy winds, properly secure materials and do not leave material double-stacked on job sites.

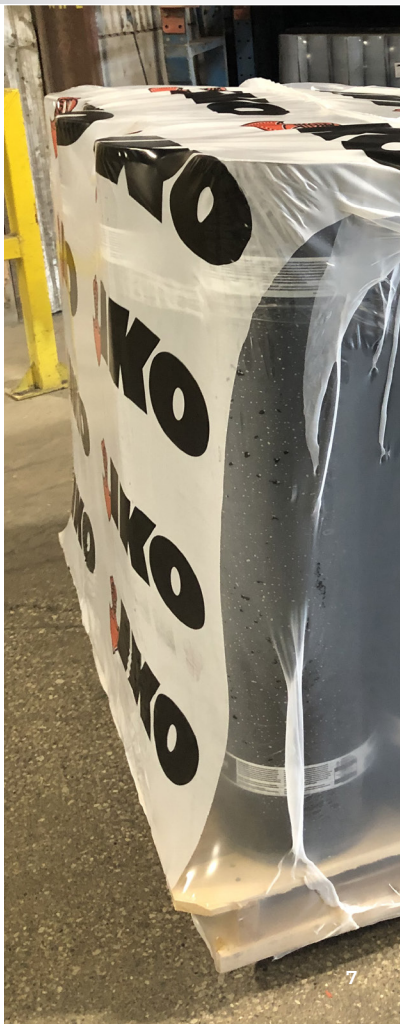

Here's a short list of pro tips that IKO has developed through its successful history, in conjunction with input from our valued IAAP-registered professional contractors:

1. Cut the 45-degree corner-cut at the same time as cutting the membrane to length.
2. Always use chalk lines to ensure straight membranes.
3. Ensure all felts are broomed during application.
4. Never cut membranes on newly installed membranes.
5. Membrane flashings can only be installed in 39.37-inch (1-m) widths.
6. Base sheet flashing membranes — 8 inches onto field. Cap sheet flashings — 6 inches onto field.
7. Relax all membranes prior to installation.
8. Always store rolls upright with the side lap up.
9. On mop base/torch cap system, ensure asphalt does not spill over onto the adjacent roll's surface polyfilm. If asphalt does spill over, it must be removed (chipping off in cold weather



or heating and scraping off in warmer weather).

10. When torching base to IKO Protectoboard™, preheat protection board, then burn film off on roll. Move roll forward. Repeat.
11. Apply board stock immediately after the application of IKO Millennium™ Adhesive. Should the ribbons start curing prior to board installation, remove them and apply new ribbons.
12. Protectoboard, Protectobase™ and ShieldBase™ only need to be scored and snapped to yield two pieces. No need to cut right through the product. Ensure that Protectobase and ShieldBase are scored and snapped from the membrane side only. No need to cut right through the product.
13. When working with self-adhering flashing membranes, only remove release film in the area where it will be first bonded. Remainder of film can be released at time of bond.
14. **Always** roll self-adhering membranes with a hand roller or 75-lb. floor roller.



18



19



20

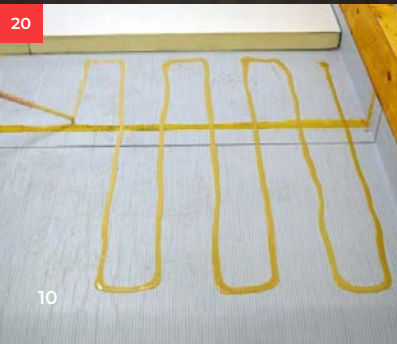

10

15. When cutting self-adhering membranes, pull both pieces away from the cut (do not pull up — this will avoid pulling the release film if the film portion is not cut properly).
16. When measuring for a membrane end lap, most trowels (and some knives) are 6 inches in length, which provides a convenient measurement guide.
17. S.A.M.® Adhesive — Flash-off time is minimum 30 minutes; re-coat after four hours.
18. Apply pressure to all IKO Millennium®-adhered systems.
19. Properly torque screws and plates on all mechanically attached systems. Do not over-torque.
20. IKO Millennium ribbons should be applied at approximately a 1/2 to 3/4-inch-wet beads in a square end pattern.
21. Melt polyfilm on all underlying self-adhered membrane laps.

22. 13-inch cover strips are required on IKO Fast-N-Stick®, ShieldBase™, Armourvent® and Protectobase™ end laps.
23. Pitch pockets are to be 2 inches off the roof deck and filled and coated with IKO MS Detail™.
24. Apply IKO MS Detail a minimum of 2 inches up penetrations and 2 inches onto cap membrane.
25. Gussets (size 3 inch x 6 inch) must be applied to all inside corners.
26. Gussets must be applied to all outside corners as well.



22



23



25



26



General Requirements

1. Install only as much insulation as can be covered with the completed roof assembly within the same day.
2. Do not install wet, damaged, warped or defective insulation.
3. Install insulation boards in staggered joint fashion in one direction. If there are multiple layers of insulation, all joints between boards in subsequent layers must be staggered a minimum of 12 inches (300 mm) in both directions.
4. Install insulation boards so that the sides and ends of the boards make contact along the entire length and width. Do not kick insulation boards into place.
5. Gaps between insulation boards that exceed 1/4 inch (6 mm) must be filled with similar insulation material.
6. Fit insulation neatly around all penetrations.

7. Tapered insulation is recommended around all drains to create a sump for drainage. Mitering insulation is recommended at drain sump points to minimize sharp edges/transitions. It is recommended that drain sumps be located a minimum of 1/2 inch (13 mm) below the finished roof surface. Minimum size of sump will be 3 feet x 3 feet (914 mm x 914 mm).
8. Insulation boards shall be mitered and filled at any slope ridges to prevent open joints.
9. Insulation boards must be firmly attached to the substrate with screws and plates, hot asphalt or adhesives. Secure insulation as specified by the system performance level required.
10. Where required, install saddle or cricket systems in accordance with roof specifications.
11. Heat-applied roofing membranes may not be applied directly over insulation without first installing a separation panel.
12. When hot asphalt is applied indirectly over expanded polystyrene insulation boards, take precautions to prevent asphalt contacting the insulation (through joints/gaps). For example, where a single layer of separation panel is specified, all joints in the separation panel layer shall be taped or sealed.



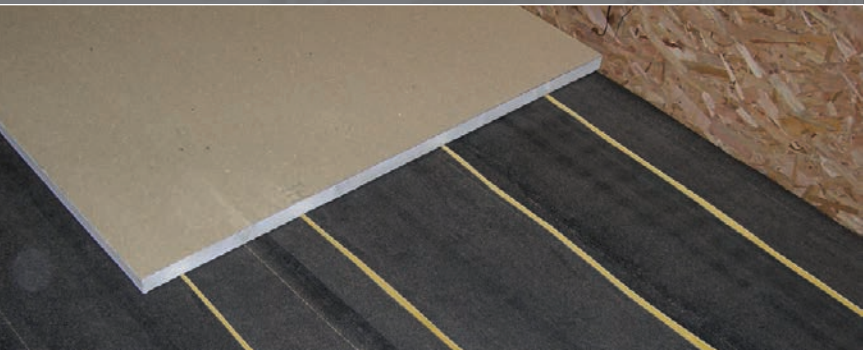

Adhesive-Adhered

- All work surfaces should be clean, dry and free of dirt, dust, debris, oils, loose and/or embedded gravel, unadhered coatings, deteriorated membrane and other contaminants that may result in a surface that is not sound or is uneven.
- Do not apply to wet surfaces. Not recommended for use with insulation boards larger than 4 feet x 4 feet (1,220 mm x 1,220 mm). Do not use warped or curled insulation boards. All insulation boards must lay flat upon the roof surface.
- As adhesive is applied, immediately place insulation or board product into wet adhesive (in cartridges). Press into the adhesive and hold in place until adhesive stops rising, thus ensuring that a contact patch of adhesive achieves the desired 2 to 3-inch (50 to 75-mm) flattened width continuously throughout the full pattern. Do not allow the adhesive to skin over. Eliminate uneven surfaces to ensure positive contact between the insulation or board product and substrate.

These procedures apply to the IKO Millennium™ Adhesive cartridges:

1. With a utility knife, remove the molded tips at the groove from the IKO Millennium mixing head.
2. Attach the included mixing nozzle to the threaded mixing head.
3. Place the cartridge into the appropriate IKO Millennium applicator, manual, electric, etc.
4. Prior to application, discard a small portion of mixed material to ensure the product is properly mixed. Apply adhesive
5. The temperature of the adhesive prior to application should be between 18°C-29°C (65°F-85°F) for best results.
6. Should IKO Millennium cartridges freeze or be stored beyond required temperatures, store at room temperatures for at least 24 hours prior to use.

directly to the substrate, using a ribbon pattern. Space 1/2 to 3/4-inch-wide beads, 12 inches (300 mm) on centre (in line with wind uplift requirements), to achieve proper coverage rates for insulation and suitable board product attachment.

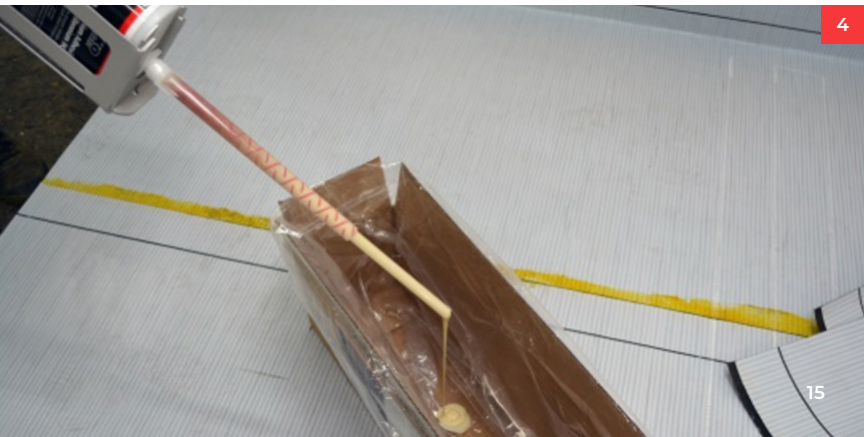



Mechanical Attachment

1. Unless otherwise specified, fastening requirements shall be in accordance with the patterns detailed in this guide or IKO's Technical Specifications Manual.
2. Only screws and plates are acceptable mechanical fasteners for insulation.
3. Nail attachment of roof insulation to a nailable deck is not acceptable.
4. Minimum fastener penetration should be:
 - a. Steel — 3/4 inch (19 mm).
 - b. Concrete — 1 inch (25 mm).
 - c. Plywood or wood plank — 1 inch (25 mm).

Hot Asphalt-Adhered

1. A full coat of asphalt shall be applied at a rate of 25 lbs. per 100 square feet.
2. The asphalt application temperature shall not exceed 199°C (390°F) at the point of contact.
3. Insulation boards adhered in asphalt must have pressure applied to create a good bond.





General Requirements

1. All side laps shall be a minimum of 3 1/2 inches (90 mm), and all end laps shall be a minimum of 6 inches (150 mm).
2. The side laps of the base sheet shall be staggered a minimum of 12 inches (300 mm) from the cap sheet. Base sheet end laps shall be staggered 24 inches (610 mm) from the cap sheet end laps. "Soldiering" of end laps is acceptable for IKO Fast-N-Stick® 180-Base, Protectobase™ and ShieldBase™ only.
3. All end laps shall have a 45-degree section removed to form a positive waterstop.
4. Most surfaces for heat-fused membranes must be primed with IKO Mod-Bit Primer. Hot asphalt-applied base sheet must be primed with IKO Standard Asphalt Primer. All substrates for self-adhered base sheets must be primed with IKO S.A.M.® Adhesive or IKO S.A.M. Adhesive LVC.

5. Remove all wrapping tape and labels before beginning membrane installation. The sheets must be unrolled, allowed to relax and then rerolled prior to installation.
6. Begin installation at the low point of the roof. Unroll and align base sheet prior to attachment. Use chalk lines where necessary to ensure proper alignment. Ensure side laps are oriented so as not to buck the flow of water to drains. Note: If a drain is the lowest point, start here with the edge of the base sheet bisecting the centreline of the drain.
7. In two-ply applications, it may be convenient to use a half-width of base sheet as the starter ply.
8. All base flashings must be a polyester or composite-reinforced modified bitumen membrane.
9. The field base sheet shall terminate at all vertical surface junctions or shall extend a minimum of 2 inches (50 mm) onto any vertical surface. At parapets, the base sheet must be installed up and over the parapet and nailed on the outer parapet wall.
10. All field base sheet perimeters should be restrained at their respective termination edges with screws and a termination bar. Where perimeter insulation thickness is greater than 3 inches (75 mm), the base sheet must terminate on the parapet wall. Termination bars are not required for IKO Fast-N-Weld[®] mechanically attached base sheet installations.
11. Repair cap sheet surface areas damaged during installation with matching coloured granules. The granules can be broadcast and embedded in a coating of IKO MS Detail™ or on a heated/softened membrane surface.



Heat-Welded

1. The torch operator should be positioned in front of the roll and should use a hook or cane-type tool to pull the roll towards them.
2. Beginning at the rerolled portion of the sheet, apply the flame evenly across the back of the roll and along the exposed side lap of the previously installed sheet. The flame should be applied approximately 60% on the cap sheet and 40% on the base sheet or 60% on the top roll and 40% on the bottom roll.
3. Apply enough flame to melt the film on the back of the sheet and the lap on the previously installed sheet. Installation is correct when a small bead of bitumen can be seen in front of the roll and at the side lap, producing a nominal 1/4-inch (6-mm) bleed-out of bitumen at both sides.
4. Reroll the opposite half of the sheet and repeat the above method to complete installation of the full roll.

5. When heat-fusing membranes to Protectoboard™, the torch flame should be directed primarily at the roll. Gently preheat the top of Protectoboard immediately in front of the roll.
6. When heat-fusing membranes to gypsum board, aim the torch primarily at the top of the roll.
7. On cap sheets, exposed asphalt at the side or end laps may be covered with the same coloured granules while the compound is hot.
8. On granular cap sheet end laps, the end lap granules shall be embedded with a torch and trowel prior to mating with the next cap sheet. Heat is applied to both the membrane and the trowel to embed the granules into the bitumen — they should not be scraped off the cap sheet.
9. On cap sheet side laps, if the factory-provided 3 1/2-inch (90-mm) side lap is not available, then the side lap granules shall be similarly embedded with a torch and trowel to create the required overlap.



Flame-Free — "Picture Framing"

1. On larger roof areas where heat-welding has been specified, it may be advantageous to heat-weld the base and cap sheets in the field of the roof, in combination with ArmourStick™ HD membrane installation at roof perimeters and near any rooftop structures. This installation process is often referred to as "picture framing."
2. The field of the roof is completed as above for heat-welding. Base sheet installation is terminated 39 inches (1 m) from all walls.
3. Over the field base sheet, ArmourStick HD-Base Sheet shall be lapped over the field base by 6 inches (150 mm) and then terminated at the base of the parapet/wall. A base sheet flashing strip is then installed up the parapet/wall per standard procedures.
4. Install the field cap sheet to align and terminate with the 6-inch (150-mm) overlap in base sheets.
5. Install ArmourStick HD-Cap sheet, overlapping the field cap sheet by 6 inches (150 mm) and terminating at the base of the parapet/wall. Prepare the cap sheet lap area by embedding the granules in a layer of AquaBarrier® Mastic.
6. A cap sheet flashing strip is then installed up the parapet/wall per standard procedures.
7. Please refer to detail FF-1 on page 62.



Hot Asphalt-Adhered

1. IKO requires that all asphalt be applied at the equiviscous temperature (EVT) range specifically printed on the asphalt carton or bill of lading.
2. When installing felts, asphalt at the point of application shall be the EVT plus or minus 13°C (55°F), but never less than 219°C (426°F).
3. Asphalt for separation panel, base sheet, ply sheet or cap sheet applications shall be 25 lb./100 ft² (1.2 kg/m²) +/- 20%.
4. Keep the asphalt within 3 feet (1 m) of the roll. In cool/windy weather, this distance may need to be shortened.
5. All laps shall be fully adhered in hot asphalt. A nominal 1/4-inch (6-mm) bead of asphalt indicates a fully sealed joint.
6. Broom base sheets to prevent voids and ensure embedment.



7. Minimize foot and equipment traffic on freshly installed membranes.
8. Optionally, the laps may be heat-fused, ensuring a nominal 1/4-inch (6-mm) bleed-out.
2. Install a 39 3/8-inch (1-m) wide ply that laps the first 39 3/8-inch (1-m) ply by 30 1/16 inches (764 mm).
3. Lap the successive plies by 30 1/16 inches (764 mm).*

*Other ply sheet configurations are available at iko.com.

4 Ply BUR Membrane Roofing System

1. Install four starter strip plies: one at 9 27/32 inches (250 mm), one at 19 11/16 inches (500 mm), one at 29 17/32 inches (750 mm) and one at 39 3/8 inches (1 m) wide.

Bitumen Application (per 100 sq. ft.):

Applications	Inter-Ply Mopping	Pour Coat	Glaze Coat	Adhesion
BUR Inorganic Felts	25 lb.	75 lb.	Not Required	25 lb.
Modified Bitumen	25 lb.	Not Required	Not Required	25 lb.



Multiple-Ply “Hybrid” Membrane Roofing System

1. Apply one layer of the SBS modified bitumen base sheet or mopping grade to the suitable substrate and follow with additional ply sheets of glass felt as previously indicated in the sections detailed above. Consult the IKO Limited Warranty brochure as posted at IKO.COM/COMM for the membrane options to achieve specific Limited Warranty terms.
2. Alternately, two plies of IKO 180-SS-Base sheet may be installed with flood coat and gravel surfacing.



Cold Adhesive-Adhered

1. Keep product warm until ready to install.
2. IKO Cold Gold® Adhesive should be applied at temperatures above 4°C (40°F).
3. Unroll and allow membrane to relax prior to use.
4. Using a 1/4-inch V-notched trowel or squeegee, coat the roof surface to receive the base sheet with Cold Gold Field Adhesive.
5. Apply adhesive to within 2 inches (50 mm) of all laps. The remaining lap area shall be heat-sealed using a hot air welder (NOT open flames), ensuring a nominal 1/4-inch (6-mm) bleed-out.
6. Back-roll membrane to ensure full bond.
7. Roll the sheet with a 75 to 100-lb. roller.
8. Clean tools with mineral spirits.

Self-Adhered

1. Where required, prime substrates with IKO S.A.M.[®] Adhesive or IKO S.A.M. LVC Adhesive. Flash-off time shall be a minimum of 30 minutes (longer in cooler temperatures).
 - a. All surfaces should be clean, dry and free of oil, grease, asphalt, dirt or other materials.
 - b. Apply by brush, roller or mechanical sprayer, between -10°C and 40°C (14°F-104°F).
 - c. Ensure all primers are dry prior to proceeding with membrane installation
 - d. Mineral spirits are recommended for site and tool cleanup, prior to curing.
 - e. Membrane must be applied within 4 hours of priming the surface.
2. Unroll base sheet — allow relaxing — and set into starting position. Do not remove the release film at this stage.



3. While aligned, remove release film and press base sheet into full contact with the substrate.
4. Roll the membrane with a 75 to 100-lb. roller to promote proper bond.
5. Align the second base sheet with the first by unrolling and then fully rerolling, to start at the beginning of the second roll. Remove the release film from the selvage edge of the first sheet, exercising care not to contaminate the exposed adhesive surface. Begin installation by removing the release film from the second sheet while it is being unrolled and lapped onto the first sheet, taking care to maintain alignment.
6. Self-adhered base sheets with a sanded top surface require end lap area preparation with IKO S.A.M.[®] Adhesive or IKO S.A.M. Adhesive LVC.
7. For end laps with IKO Armourvent[®] Base membranes, butt adjoining end sections closely and centre a 13-inch (335-mm) strip of either IKO Torchflex[™] TP-180-FF-Base or IKO TorchTape[™] 180-FF over the butt joint and heat-fuse to both sides to complete the end lap.
8. All self-adhering side laps are to be buttered if the torch-on cap isn't installed the same day. All membrane side and end laps on flameless systems are to be hot-air heat-welded.





Mechanically Fastened

1. The IKO Fast-N-Weld® system uses two different base sheets (Fast-N-Stick® 180-Base and Fast-N-Stick HD-Base); however, the installation procedures are common to both.
2. Dry-fit the base sheet into starting position. Dry-fit the second sheet into place and fold over, exposing the first sheet's surface side lap. Remove the protective plastic film from the selvage edge, being careful not to

contaminate the exposed bitumen and, starting from the middle of the sheet, install screws and plates at the appropriate fastener spacing. Locate fasteners towards the outer edge of the side lap to yield the largest amount of adhered area.

3. Apply moderate tension to the base sheet while fasteners are driven to reduce buckling and wrinkling in the base sheet. It is recommended to prime the fastener plates with IKO S.A.M.[®] Adhesive (or IKO S.A.M. Adhesive LVC). Place and align adjoining sheet into position, remove the protective plastic release film from the bottom of the base sheet and place over the fastened side lap of the first base sheet. Finish the joint by pressure-rolling the entire length of the joint.
4. For end laps, overlap the base sheets at least 6 inches (150 mm) and drive four fasteners through both sheets, spacing the fasteners equally across the entire width of the sheet. (Note: These base sheets can be soldiered.) Finish by using a 13-inch TorchTape™ 180-FF, and extend over the full sheet width. Heat-fuse covering all end lap fasteners. Position the cover strip so that it falls at the midpoint of the fasteners. If the base sheet is to be left exposed to weather, the seams shall be heat-sealed at the edges using a propane torch and round-nosed trowel. This is commonly known as “buttering” the seams. This practice shall apply to both end and side laps in cases where the cap sheet application cannot be completed the same day.
5. For perimeters and corners, apply enhanced fastening as required.
6. Cut strips of Torchflex™ TP-180-FF-Base or use TorchTape 180-FF to cover the exposed perimeter and corner fasteners prior to applying the cap. Single-row fasteners can be covered with a 6-inch (150-mm) strip, and the corner rows can be covered by one strip that is 13 inches (335 mm) wide. Heat-fuse the cover strips.

7. All Fast-N-Weld® systems require pre-securement by mechanical fasteners of the polyisocyanurate insulation prior to base sheet installation, as follows:
 - a. Two (2) fasteners/
4 feet x 4 feet
(1.2 m x 1.2 m) sheet.
 - b. Four (4) fasteners/
4 feet x 8 feet
(1.2 m x 2.4 m) sheet.
8. Fasteners used in the field of the roof shall be within 2 inches (50 mm) of the base sheet termination. Exposed fasteners will be covered by the base sheet flashing.
9. During cold weather, the side laps of the Fast-N-Stick® 180-Base can be conditioned with careful use of a roofer's torch prior to sealing. This will warm the side lap and promote better sealing once the laps are closed.
10. Screws for the Fast-N-Weld system shall be #14 screws, with a 2.4-inch (61-mm) round barbed steel plate for all CSA-rated assemblies.

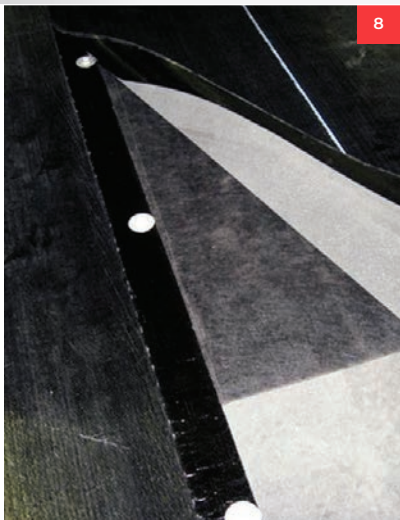

MODIFIED BITUMEN FLASHING DETAILS

Title	Number
Angled Cut End Lap	MB-1
Staggered End End Lap	MB-2
Roof Edge with Base Flashing and Cap Sheet Flashing	MB-3
Vent Pipe Flashing	MB-4
Support Column Flashing	MB-5
Parapet/Curb Flashing on All Substrates	MB-6
Shingle Roof Tie-In	MB-7
Reglet Mounted Counter Flashing	MB-8
Surface Mounted Counter Flashing	MB-9
Masonry Coping	MB-10
Metal Coping (24" Max. Parapet Height)	MB-11
Through Wall Scupper	MB-12
Downspout Scupper Box	MB-13
Cast Iron Roof Drain	MB-14
Raised Expansion Joint	MB-15
Roof Level Expansion Joint	MB-16
Wall Expansion Joint	MB-17
HVAC Unit	MB-18
Built-Up Roof Tie-In New Roof at Same Level	MB-19
Built-Up Roof Tie-In with Tapered Edge	MB-20
New Pitch Pan with Single Section Flashing	MB-21

Title	Number
Support Sleeper	MB-22
Outside Corner	MB-23
Inside Corner without Cant Strip	MB-24
Termination Bar	MB-27
Base Sheet Perimeter Attachment — Horizontal	MB-28
Base Sheet Perimeter Attachment — Vertical	MB-29
Base Sheet Perimeter Attachment — Angle	MB-30
Protectobase™ at Parapet Detail	MB-31
Perimeter Flame Free	FF-1
Perimeter Flame Free - Low Temperature	FF-2

Please scan here to view our modified bitumen fastening details online in the **IKO Technical Specifications Manual** located at IKO.COM/COMM:



MODIFIED BITUMEN FLASHING DETAILS

DETAIL NUMBER: MB-1

Angled Cut End Lap

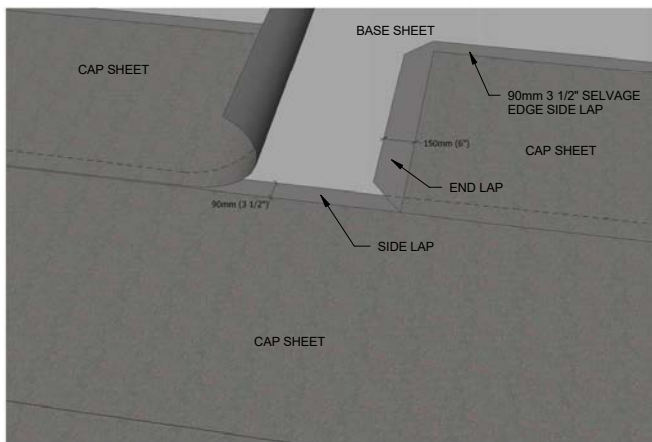

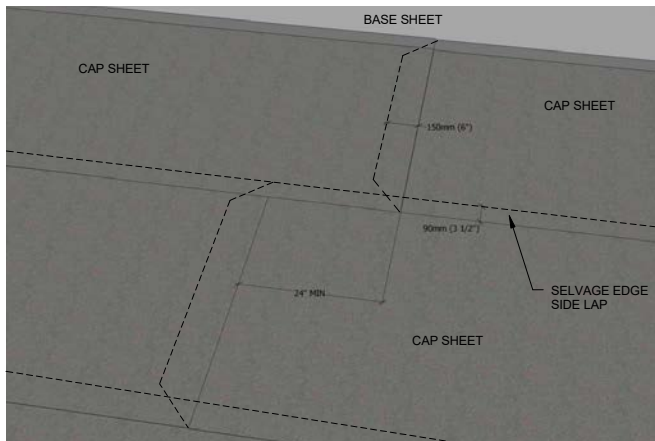
DETAIL NUMBER: **MB-2****Staggered End End Lap**

MODIFIED BITUMEN FLASHING DETAILS

DETAIL NUMBER: MB-3

Roof Edge with Base Flashing and Cap Sheet Flashing

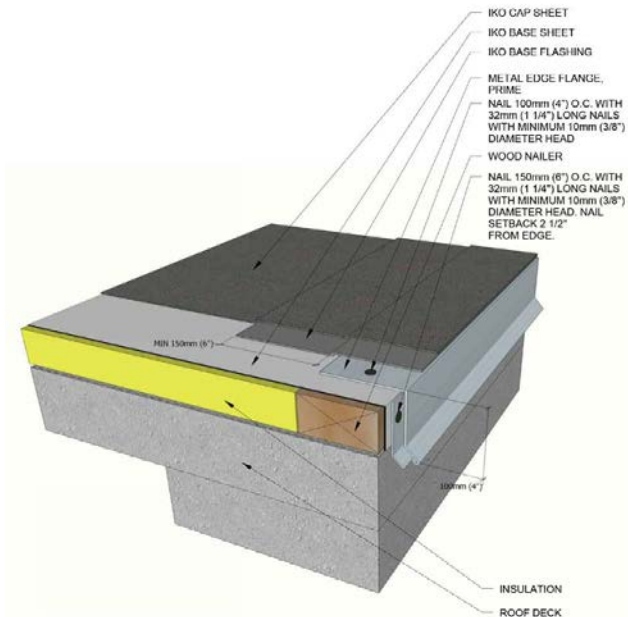

DETAIL NUMBER: MB-4

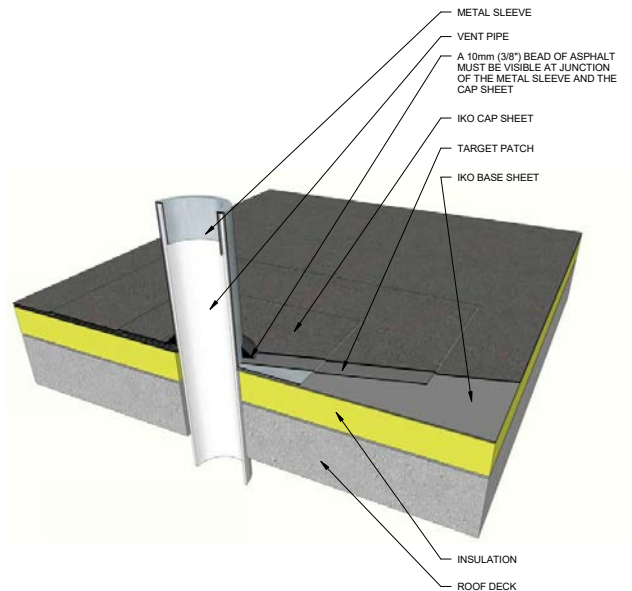
Vent Pipe Flashing

MODIFIED BITUMEN FLASHING DETAILS

DETAIL NUMBER: MB-5

Support Column Flashing

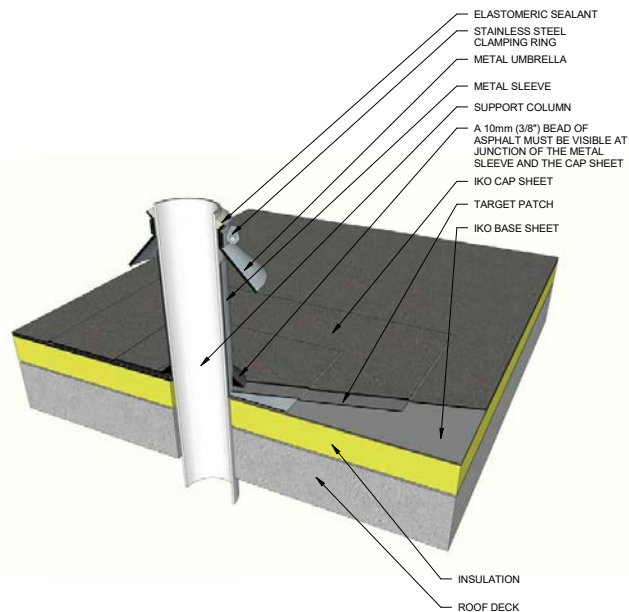

DETAIL NUMBER: MB-6

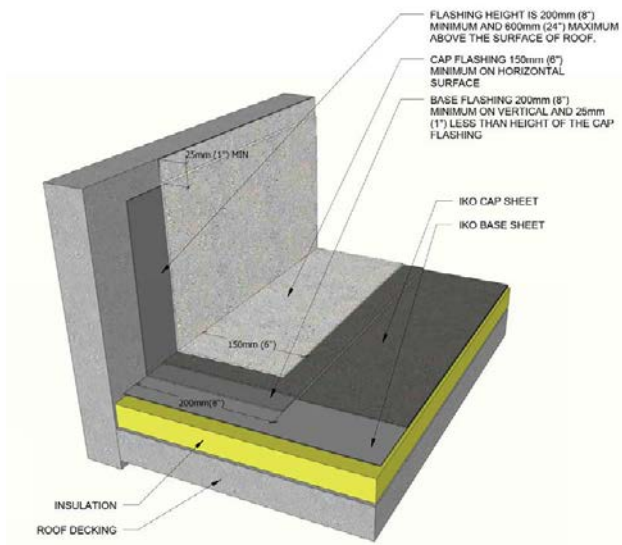
Parapet/Curb Flashing on All Substrates

MODIFIED BITUMEN FLASHING DETAILS

DETAIL NUMBER: MB-7

Shingle Roof Tie-In

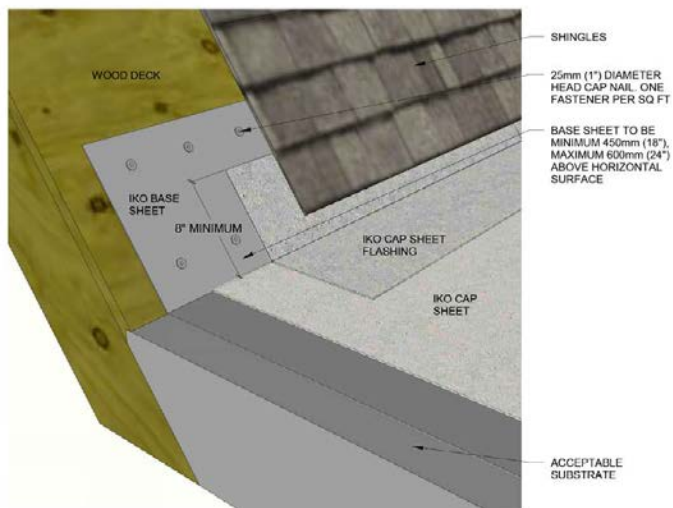

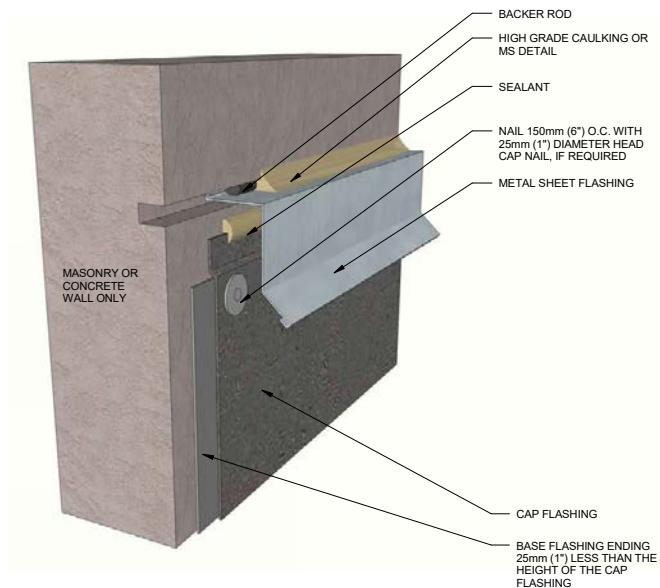
DETAIL NUMBER: **MB-8****Reglet Mounted Counterflashing**

MODIFIED BITUMEN FLASHING DETAILS

DETAIL NUMBER: MB-9

Surface Mounted Counterflashing

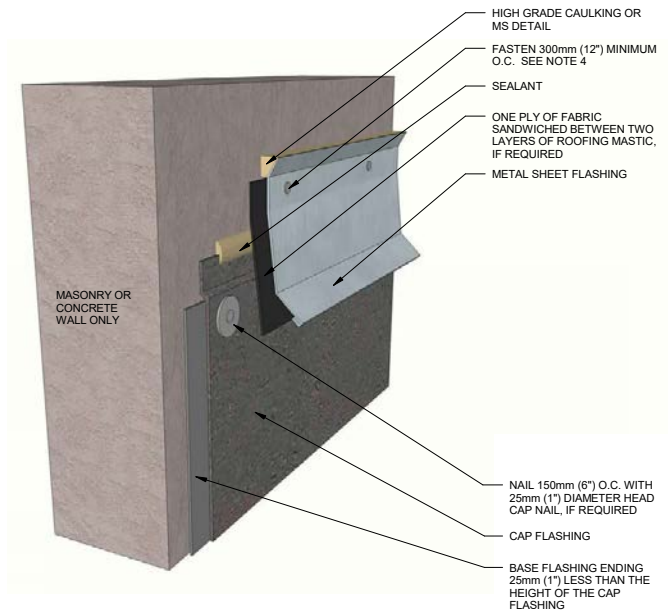

DETAIL NUMBER: MB-10

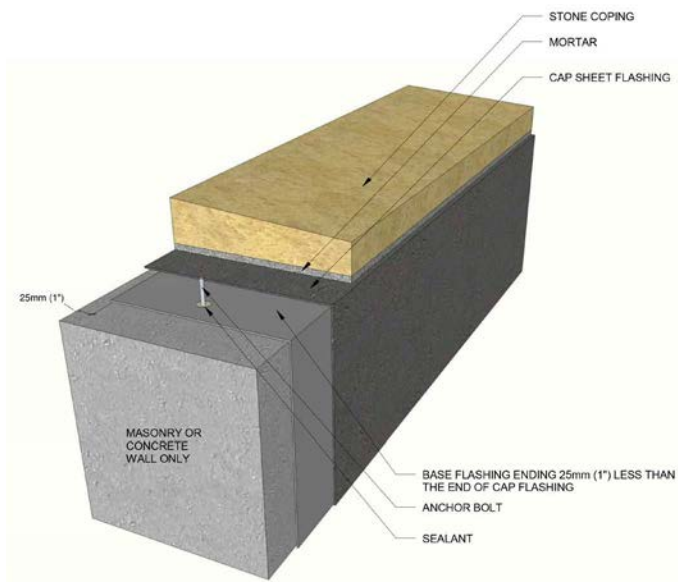
Masonry Coping

MODIFIED BITUMEN FLASHING DETAILS

DETAIL NUMBER: MB-11

Metal Coping (24" Max. Parapet Height)

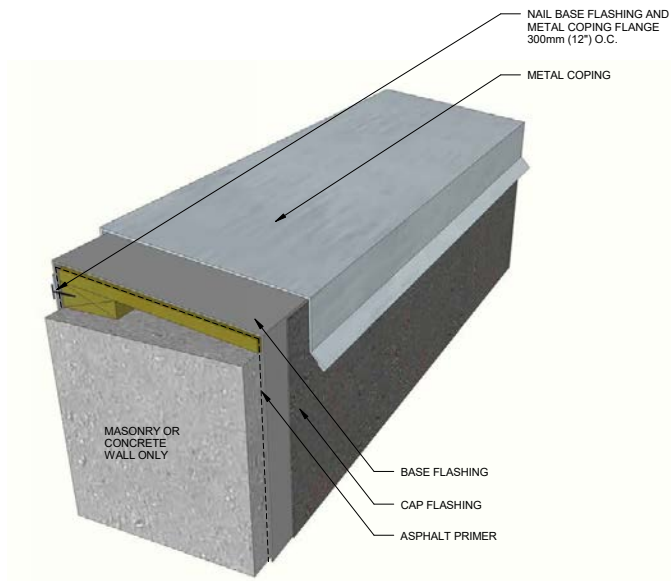

DETAIL NUMBER: **MB-12**

Through Wall Scupper

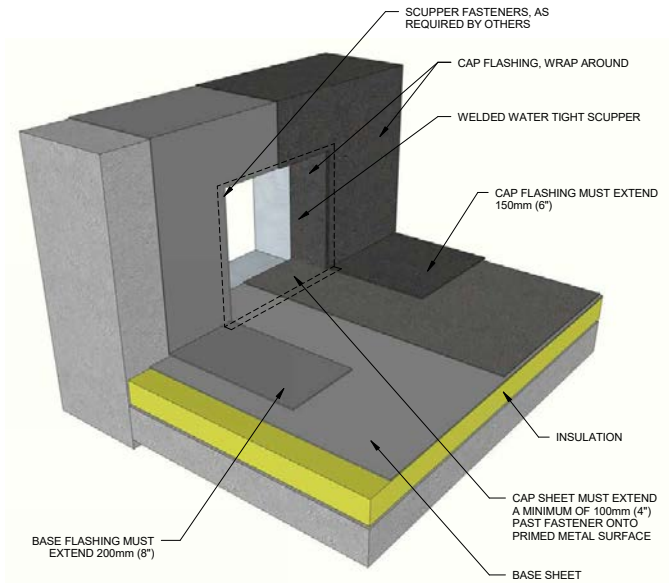

MODIFIED BITUMEN FLASHING DETAILS

DETAIL NUMBER: MB-13

Downspout Scupper Box

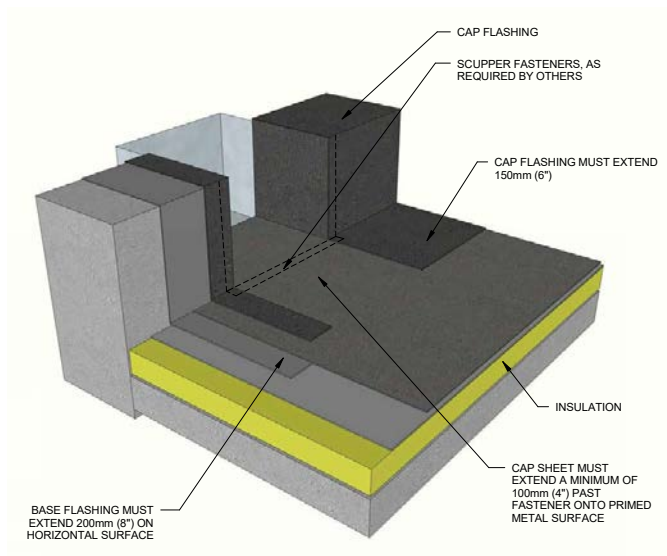

DETAIL NUMBER: **MB-14**

Cast Iron Roof Drain

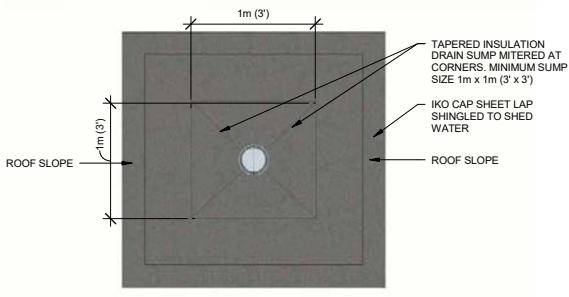
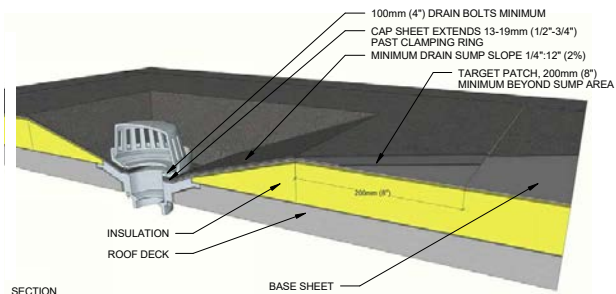

MODIFIED BITUMEN FLASHING DETAILS

DETAIL NUMBER: MB-15

Raised Expansion Joint

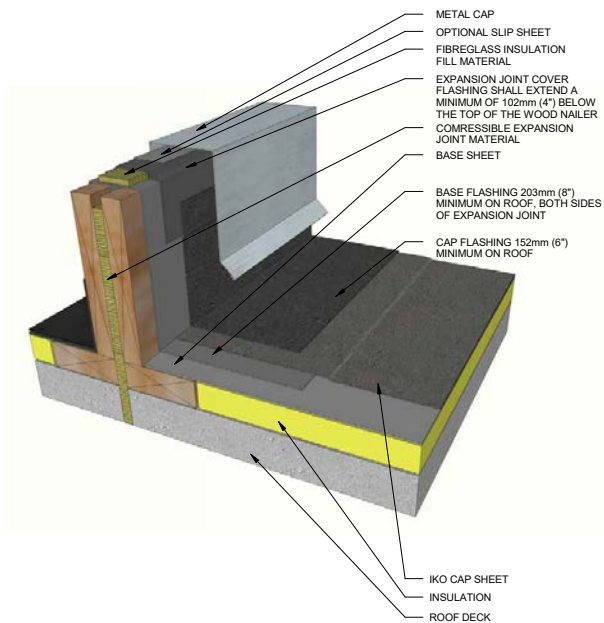

DETAIL NUMBER: MB-16

Roof Level Expansion Joint

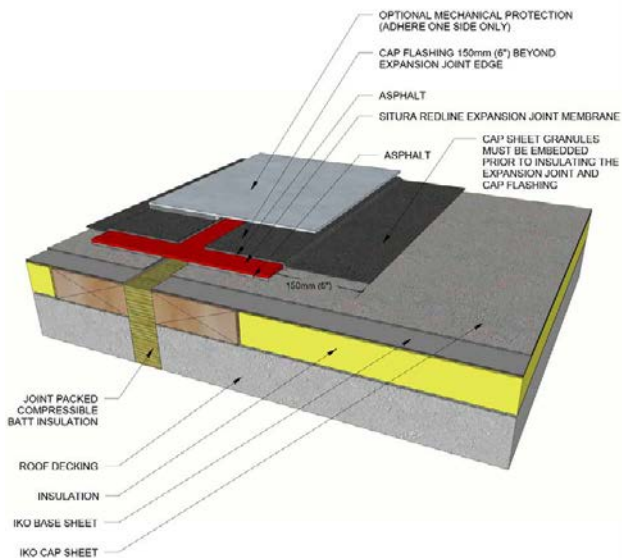

MODIFIED BITUMEN FLASHING DETAILS

DETAIL NUMBER: **MB-17**

Wall Expansion Joint

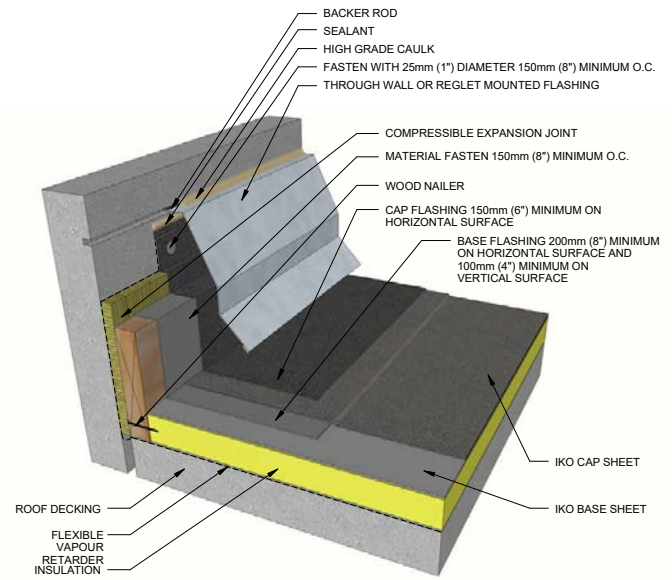

DETAIL NUMBER: **MB-18**

HVAC Unit

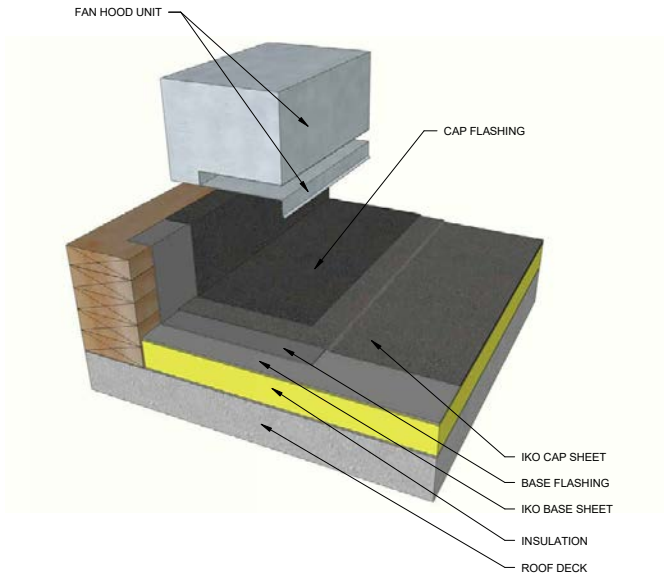

MODIFIED BITUMEN FLASHING DETAILS

DETAIL NUMBER: MB-19

Built-Up Roof Tie-In New Roof at Same Level

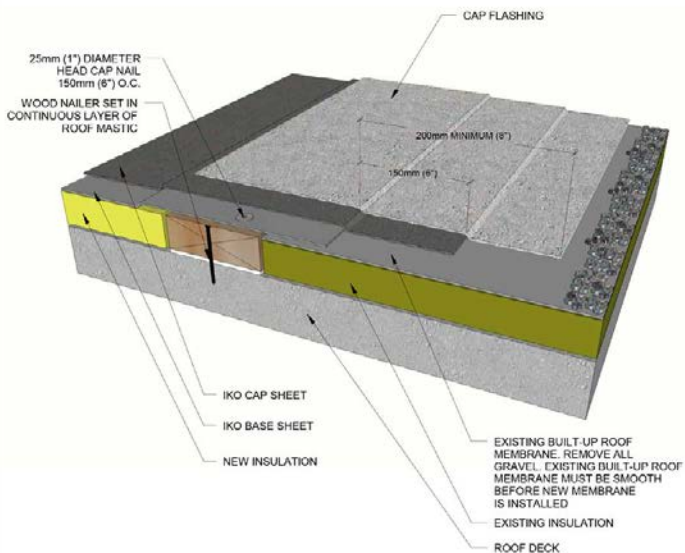

DETAIL NUMBER: **MB-20**

Built-Up Roof Tie-In with Tapered Edge

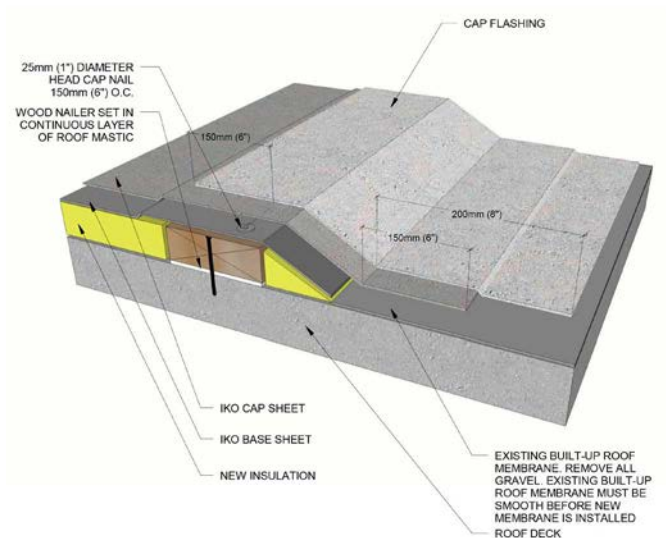

MODIFIED BITUMEN FLASHING DETAILS

DETAIL NUMBER: MB-21

New Pitch Pan with Single Section Flashing

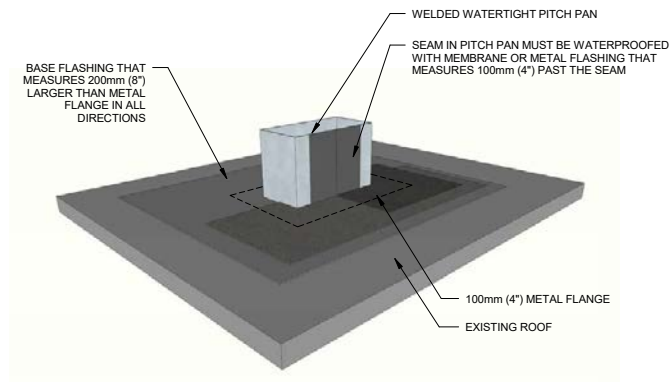

DETAIL NUMBER: MB-22

Support Sleeper

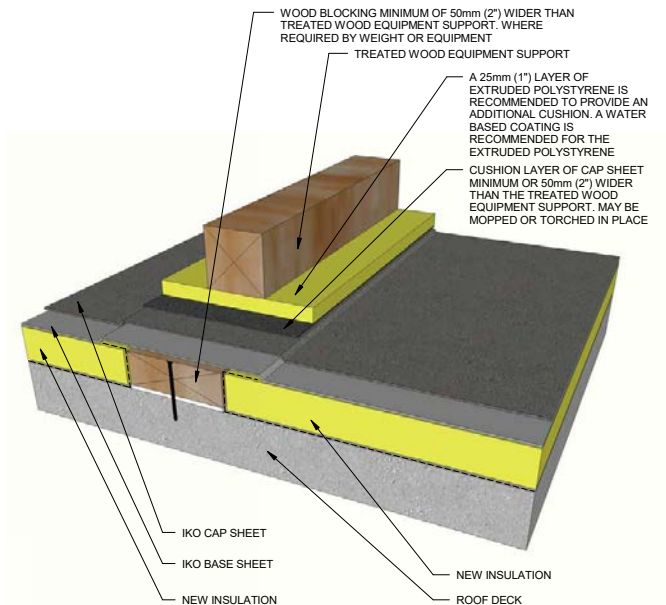

MODIFIED BITUMEN FLASHING DETAILS

DETAIL NUMBER: **MB-23**

Outside Corner

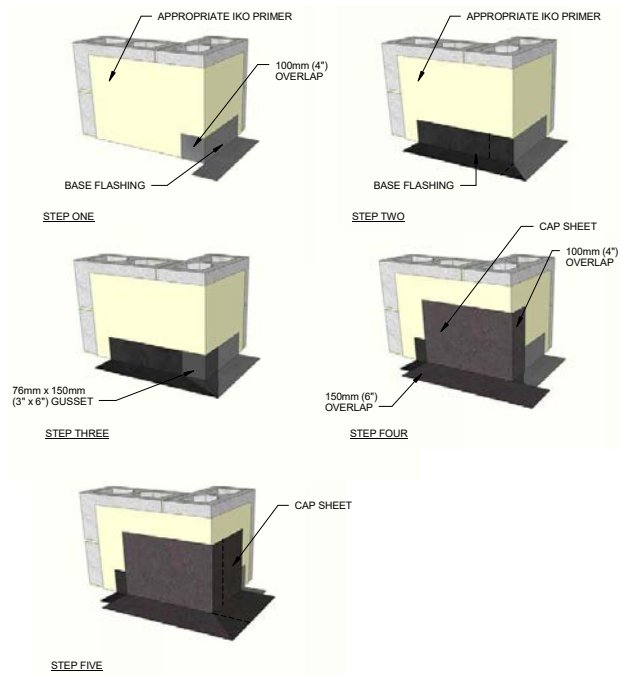

DETAIL NUMBER: **MB-24**

Inside Corner without Cant Strip

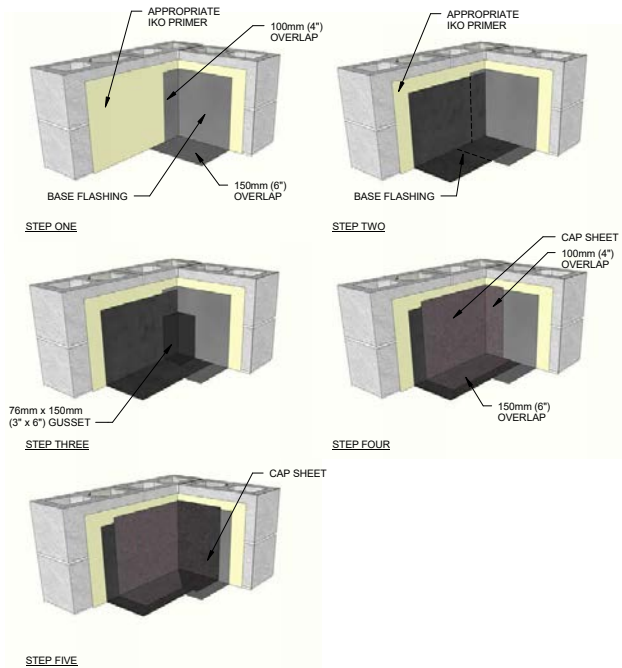

MODIFIED BITUMEN FLASHING DETAILS

DETAIL NUMBER: MB-27

Termination Bar

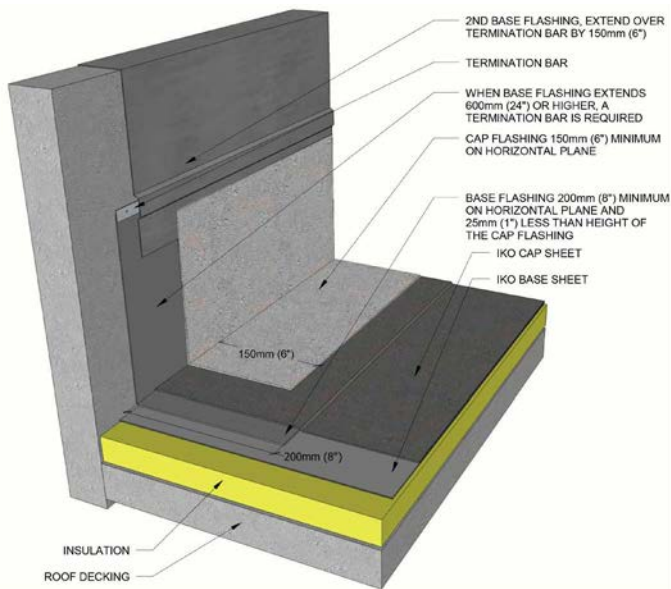

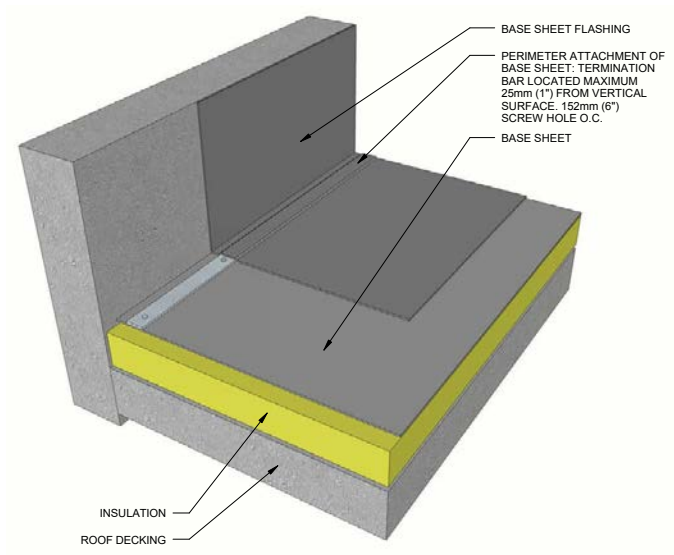
DETAIL NUMBER: **MB-28****Base Sheet Perimeter Attachment — Horizontal**

MODIFIED BITUMEN FLASHING DETAILS

DETAIL NUMBER: MB-29

Base Sheet Perimeter Attachment — Vertical

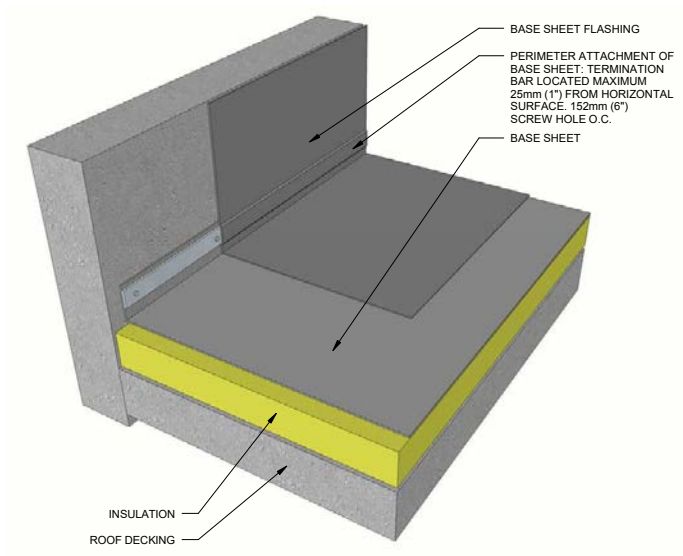

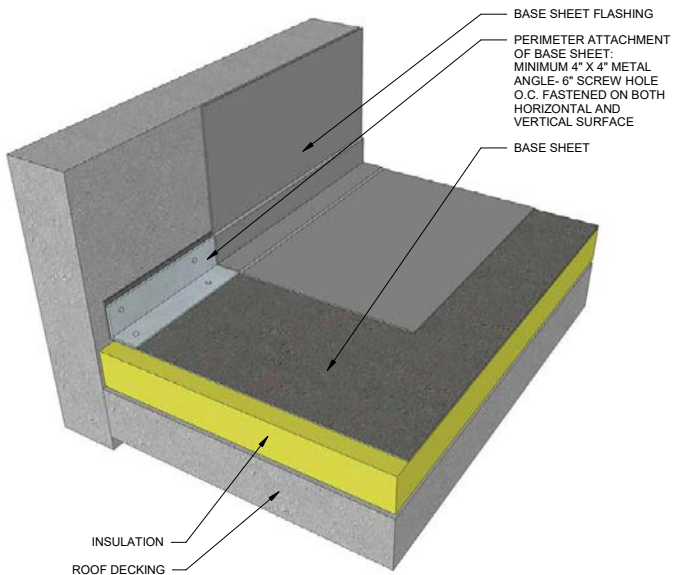
DETAIL NUMBER: **MB-30****Base Sheet Perimeter Attachment — Angle**

MODIFIED BITUMEN FLASHING DETAILS

DETAIL NUMBER: MB-31

Protectobase™ at Parapet Detail

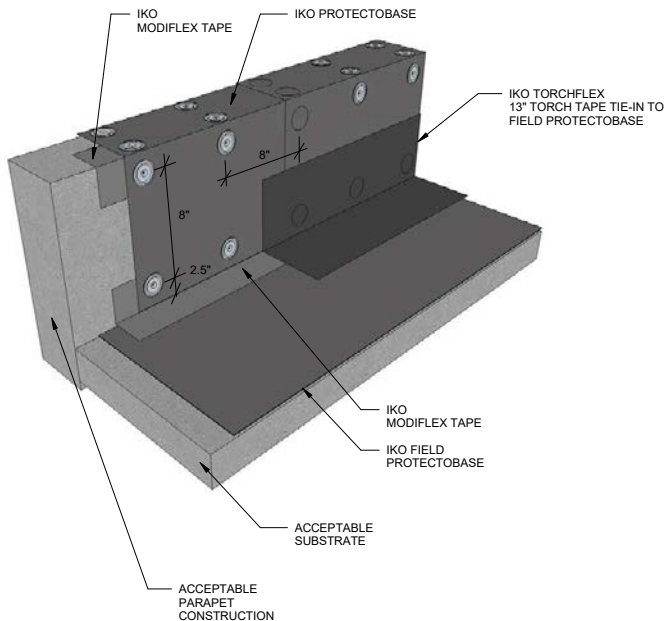

DETAIL NUMBER: FF-1

Perimeter Flame Free

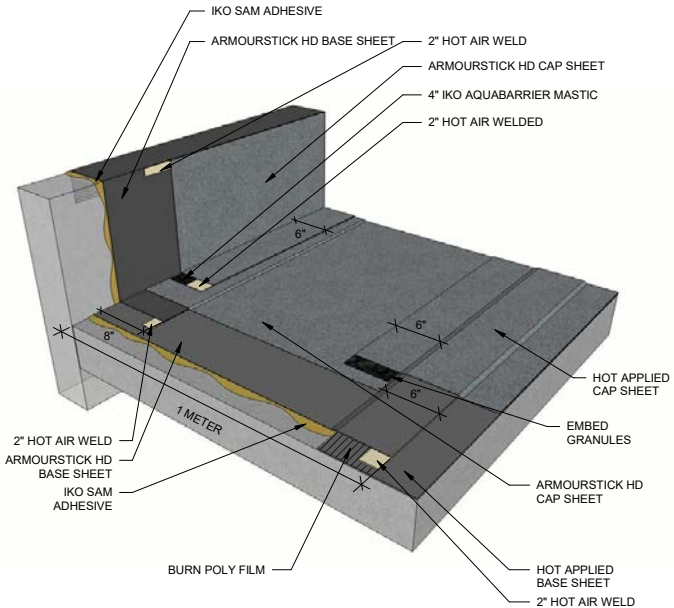

MODIFIED BITUMEN FLASHING DETAILS

DETAIL NUMBER: FF-2

Perimeter Flame Free - Low Temperature

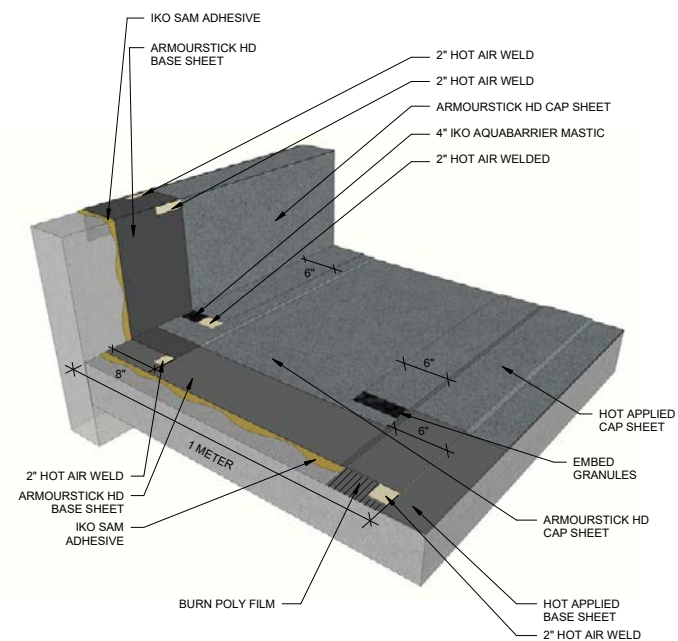

Built-Up Roofing (BUR) Flashing Details

Please scan here to view our built-up roofing (BUR) flashing details in the **IKO Technical Specifications Manual** at IKO.COM/COMM:



Insulation and Cover Board Fastening Details

Please scan here to view our fastening details in the **IKO Technical Specifications Manual** at IKO.COM/COMM:



Specify with Confidence.

Find out more about our products now by talking to an IKO Commercial Representative, your professional contractor or contact us directly at: **1-855-IKO-ROOF (1-855-456-7663)**. Or visit our website at: **IKO.COM/COMM**.

 **IKO**®
COMMERCIAL

Specify with Confidence